

1M Series Miniature Single Pole Toggle Switches

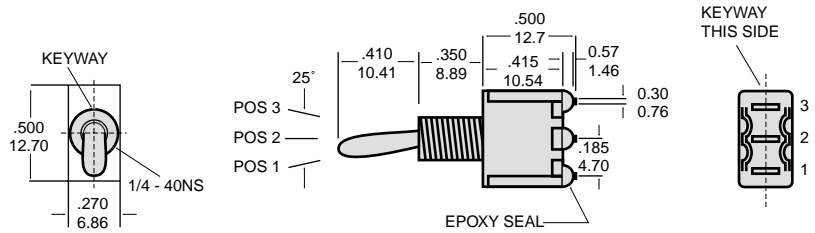

No. Poles	UL/CSA Model No.	Model No.	SWITCH FUNCTION			CONNECTED TERMINALS		
			Pos. 1	Pos. 2	Pos. 3	Pos. 1	Pos. 2	Pos. 3
SP	Q1111	1MS1	On	None	On		OPEN	
	Q1112	1MS2	On	None	Mom			
	Q1113	1MS3	On	Off	On			
	Q1114	1MS4	Mom	Off	Mom			
	Q1115	1MS5	On	Off	Mom			

MOM=Momentary

Specifications

- Contact Rating:** Dependent upon contact material
- Electrical Life:** 40,000 make-and-brake cycles at full load.
- Contact Resistance:** 10m Ω max. initial @ 2-4VDC 100mA for both silver and gold plated contacts.
- Insulation Resistance:** 1,000m Ω min.
- Dielectric Strength:** 1000 V RMS@sea level
- Operating Temperature:** -30° C to 85° C

Materials

- Case:** Diallyl phthalate (DAP)
- Toggle Handle:** Brass, chrome plated
- Bushing:** Brass, nickel plated
- Housing:** Stainless Steel
- Terminal/Switch Support:** Brass, electroton plates

Ordering Information

Model No.	Actuator	Bushing	Termination	Contact Material	Seal
UL/CSA	T1	B1	M1	Q=Silver	E=Epoxy
Q1111 1MS1	T2	B2	M2	R= Gold	N=No Epoxy
Q1112 1MS2	T3	B3	M3		
Q1113 1MS3	T4	B4	M4		
Q1114 1MS4	T5	B5	M5-1		
Q1115 1MS5	T6	B6	M5-2		
	T7	B7	M5-3		
	T8	B8	M5-4		
	T9	B9	M6		
		B10	M7		
		B11	VS2		
		B12	VS3		
		B13	VS4		
		B15	VS5		
		B16			

Contact Material Options
Q
Fixed Terminal: Silver plated over copper alloy
Moving Contact: Silver plated over copper alloy
Rated: 5 Amps with resistive load @ 120VAC or 28VDC
 2 Amps with resistive load @ 250VAC

R
Fixed Terminal: Copper alloy with gold plated over nickel plated
Moving Contact: Copper alloy with gold plated over nickel plated
Rated: .04 Volt-Amps (VA) max. @ 20V max. (AC or DC)



Phone (203) 272-2794 • Fax (203) 272-3492 • <http://www.osloswitch.com>

MADE IN U.S.A.

1M Series Miniature Double Pole Toggle Switches

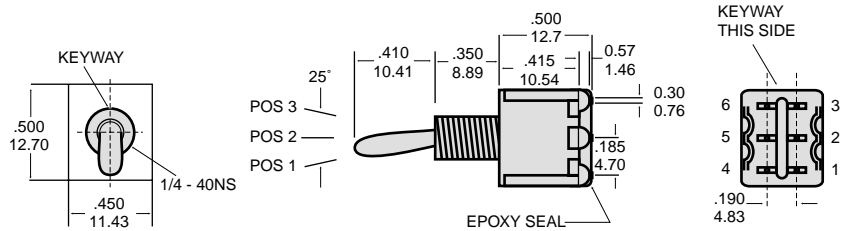

No. Poles	UL/CSA Model No.	Model No.	SWITCH FUNCTION			CONNECTED TERMINALS		
			Pos. 1	Pos. 2	Pos. 3	Pos. 1	Pos. 2	Pos. 3
DP	Q1121	1MD1	On	None	On			
	Q1122	1MD2	On	None	Mom	2-3,5-6	OPEN	2-1,5-4
	Q1123	1MD3	On	Off	On			
	Q1124	1MD4	Mom	Off	Mom			
	Q1125	1MD5	On	Off	Mom			

MOM=Momentary

Specifications and Materials: See page 1.

Ordering Information

Model No.	Actuator	Bushing	Termination	Contact Material	Seal
Q1121 1MD1	T1	B1	M1	Q=Silver	E=Epoxy
Q1122 1MD2	T2	B2	M2	R= Gold	N=No Epoxy
Q1123 1MD3	T3	B3	M3		
Q1124 1MD4	T4	B4	M4		
Q1125 1MD5	T5	B5	M5-1		
	T6	B6	M5-2		
	T7	B7	M5-3		
	T8	B8	M5-4		
	T9	B9	M6		
		B10	M7		
		B11	VS2		
		B12	VS3		
		B13	VS4		
		B15	VS5		
		B16			

Contact Material Options
Q
Fixed Terminal: Silver plated over copper alloy
Moving Contact: Silver plated over copper alloy
Rated: 5 Amps with resistive load @ 120VAC or 28VDC
 2 Amps with resistive load @ 250VAC

R
Fixed Terminal: Copper alloy with gold plated over nickel plated
Moving Contact: Copper alloy with gold plated over nickel plated
Rated: .04 Volt-Amps (VA) max. @ 20V max. (AC or DC)



Phone (203) 272-2794 • Fax (203) 272-3492 • <http://www.osloswitch.com>

1M Series Miniature Tripple Pole Toggle Switches

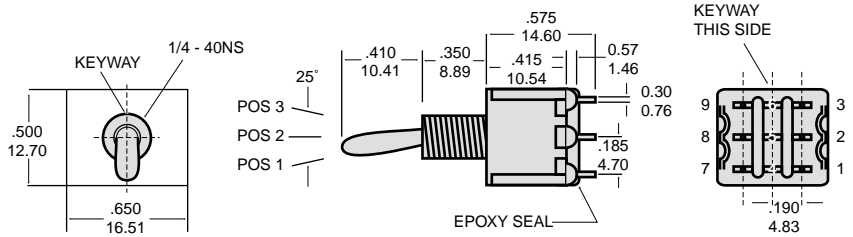

No. Poles	UL/CSA Model No.	Model No.	SWITCH FUNCTION			CONNETED TERMINALS		
			Pos. 1	Pos. 2	Pos. 3	Pos. 1	Pos. 2	Pos. 3
3P	Q1131	1M31	On	None	On		OPEN	
	Q1132	1M32	On	None	Mom			
	Q1133	1M33	On	Off	On			
	Q1134	1M34	Mom	Off	Mom			
	Q1135	1M35	On	Off	Mom			

MOM=Momentary

Specifications and Materials: See page 1.

Ordering Information

Model No.	Actuator	Bushing	Termination	Contact Material	Seal
Q1131 1M31	T1	B1	M1	Q=Silver	E=Epoxy
Q1132 1M32	T2	B2	M2	R= Gold	N=No Epoxy
Q1133 1M33	T3	B3	M3		
Q1134 1M34	T4	B4	M4		
Q1135 1M35	T5	B5	M5-1		
	T6	B6	M5-2		
	T7	B7	M5-3		
	T8	B8	M5-4		
	T9	B9	M6		
		B10	M7		
		B11	VS2		
		B12	VS3		
		B13	VS4		
		B15	VS5		
		B16			

Contact Material Options

Q
Fixed Terminal: Silver plated over copper alloy
Moving Contact: Silver plated over copper alloy
Rated: 5 Amps with resistive load @ 120VAC or 28VDC
 2 Amps with resistive load @ 250VAC

R
Fixed Terminal: Copper alloy with gold plated over nickel plated
Moving Contact: Copper alloy with gold plated over nickel plated
Rated: .04 Volt-Amps (VA) max. @ 20V max. (AC or DC)



Phone (203) 272-2794 • Fax (203) 272-3492 • <http://www.osloswitch.com>

MADE IN U.S.A.

1M Series Miniature Quad Pole Toggle Switches

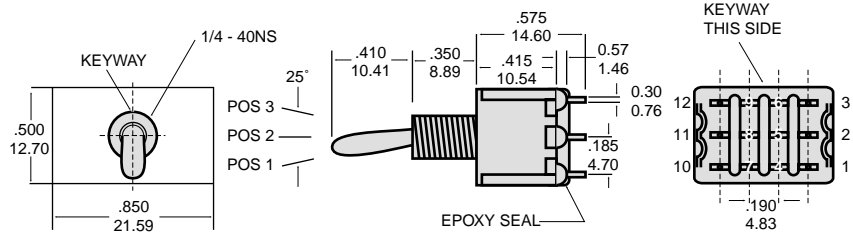

No. Poles	UL/CSA Model No.	Model No.	SWITCH FUNCTION			CONNECTED TERMINALS		
			Pos. 1	Pos. 2	Pos. 3	Pos. 1	Pos. 2	Pos. 3
4P	Q1141	1M41	On	None	On		OPEN	
	Q1142	1M42	On	None	Mom			
	Q1143	1M43	On	Off	On			
	Q1144	1M44	Mom	Off	Mom			
	Q1145	1M45	On	Off	Mom			

MOM=Momentary

Specifications and Materials: See page 1.

Ordering Information

Model No.	Actuator	Bushing	Termination	Contact Material	Seal
Q1141 1M41	T1	B1	M1	Q=Silver R= Gold	E=Epoxy N=No Epoxy
Q1142 1M42	T2	B2	M2		
Q1143 1M43	T3	B3	M3	Contact Material Options Q Fixed Terminal: Silver plated over copper alloy Moving Contact: Silver plated over copper alloy Rated: 5 Amps with resistive load @ 120VAC or 28VDC 2 Amps with resistive load @ 250VAC R Fixed Terminal: Copper alloy with gold plated over nickel plated Moving Contact: Copper alloy with gold plated over nickel plated Rated: .04 Volt-Amps (VA) max. @ 20V max. (AC or DC)	
Q1144 1M44	T4	B4	M4		
Q1145 1M45	T5	B5	M5-1		
	T6	B6	M5-2		
	T7	B7	M5-3		
	T8	B8	M5-4		
	T9	B9	M6		
		B10	M7		
		B11	VS2		
		B12	VS3		
		B13	VS4		
		B15	VS5		
		B16			



Phone (203) 272-2794 • Fax (203) 272-3492 • <http://www.osloswitch.com>

1M Series Miniature 3-Way Toggle Switches

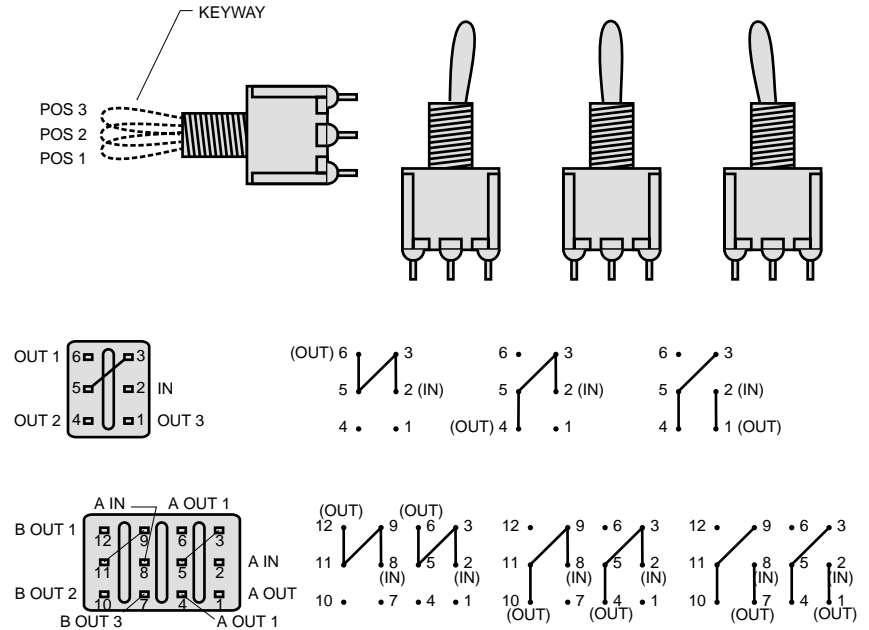

No. Poles	UL/CSA Model No.	Model No.	SWITCH FUNCTION			CONNECTED TERMINALS		
			Pos. 1	Pos. 2	Pos. 3	Pos. 1	Pos. 2	Pos. 3
3 Way	Q1126	1MD6	On	On	On	2-3,5-6	2-3,5-4	2-1,5-4
	Q1146	1M46	On	On	On	2-3,5-6,8-9,11-12	2-3,5-4,8-9,11-10	2-1,5-4,8-7,11-10

Specifications and Materials: See page 1.

Ordering Information

Model No.	Actuator	Bushing	Termination	Contact Material	Seal
Q1126 1MD6	T1	B1	M1	Q=Silver	E=Epoxy
Q1146 1M46	T2	B2	M2	R= Gold	N=No Epoxy
	T3	B3	M3		
	T4	B4	M4		
	T5	B5	M5-1		
	T6	B6	M5-2		
	T7	B7	M5-3		
	T8	B8	M5-4		
	T9	B9	M6		
		B10	M7		
		B11	VS2		
		B12	VS3		
		B13	VS4		
		B15	VS5		
		B16			

Contact Material Options

Q
Fixed Terminal: Silver plated over copper alloy
Moving Contact: Silver plated over copper alloy
Rated: 5 Amps with resistive load @ 120VAC or 28VDC
 2 Amps with resistive load @ 250VAC

R
Fixed Terminal: Copper alloy with gold plated over nickel plated
Moving Contact: Copper alloy with gold plated over nickel plated
Rated: .04 Volt-Amps (VA) max. @ 20V max. (AC or DC)



Phone (203) 272-2794 • Fax (203) 272-3492 • <http://www.osloswitch.com>

MADE IN U.S.A.

1M Series Miniature Toggle Switches Termination Options

M1 SOLDER LUG

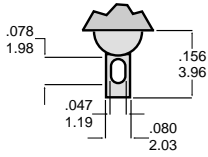

M2 P.C. MOUNT

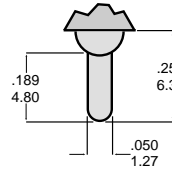

THK .030(0.76)

M3 QUICK CONNECT

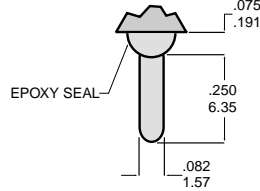

THK .030(0.76)

M5 WIRE WRAP

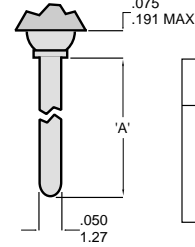

THK .030(0.76)

OPTION CODE	DIM. 'A'
M5-1	.750 (19.05)
M5-2	.964 (24.48)
M5-3	.425 (10.80)
M5-4	1.062 (26.97)

OTHER TERMINATION OPTIONS

- M6 Right Angle P. C. Mount
- M7 Right Angle P. C. Mount
- VS2 Vertical Bracket P. C. Mount
- VS3 Vertical Bracket P. C. Mount
- VS5 Vertical Bracket P. C. Mount

RE Mating Quick Connector
amp P/N 60900-1

Termination Drawing Options

M6 SPDT

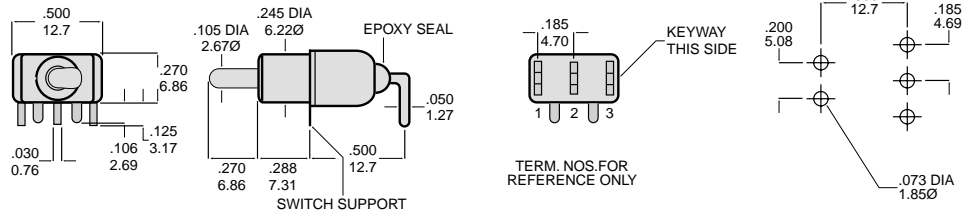

TERM. NOS. FOR REFERENCE ONLY

M6 DPDT

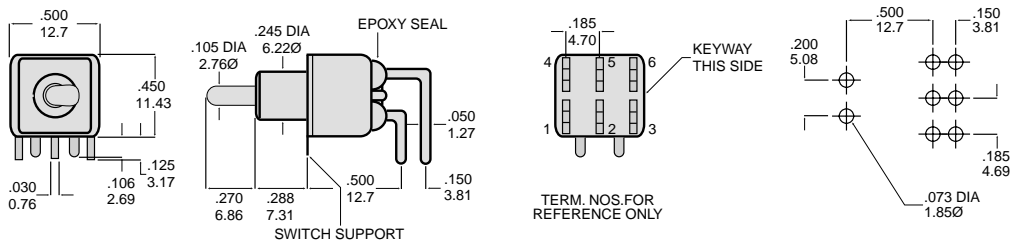

TERM. NOS. FOR REFERENCE ONLY

M7 SPDT

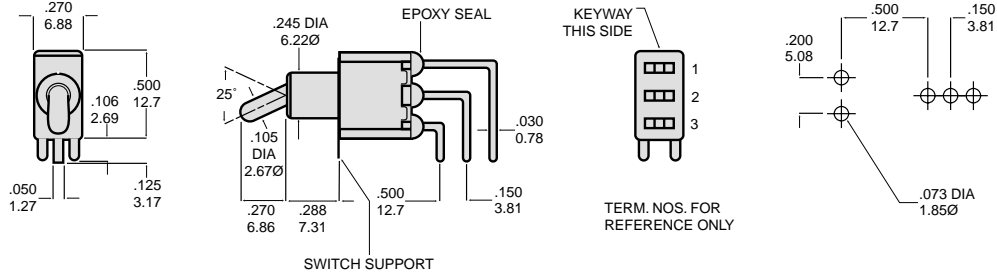

TERM. NOS. FOR REFERENCE ONLY

M7 DPDT

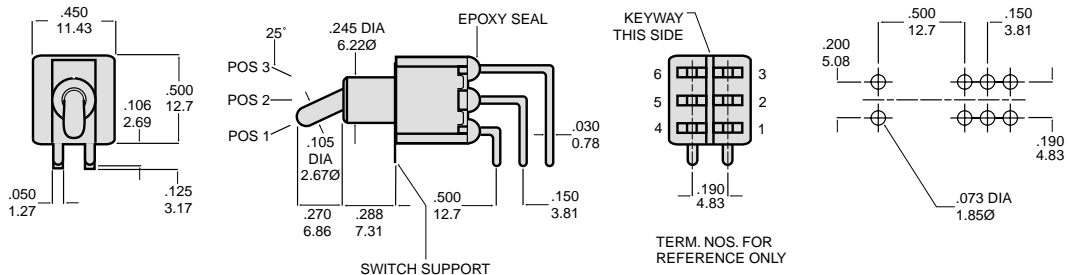

TERM. NOS. FOR REFERENCE ONLY



Termination Drawing Options (continued)

M7 3PDT

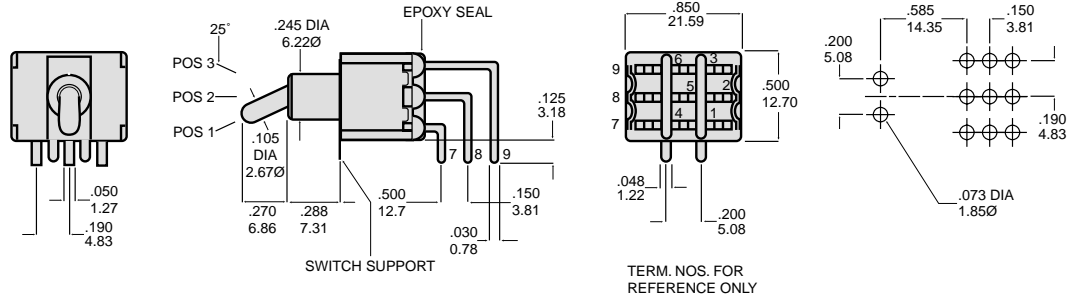

M7 4PDT

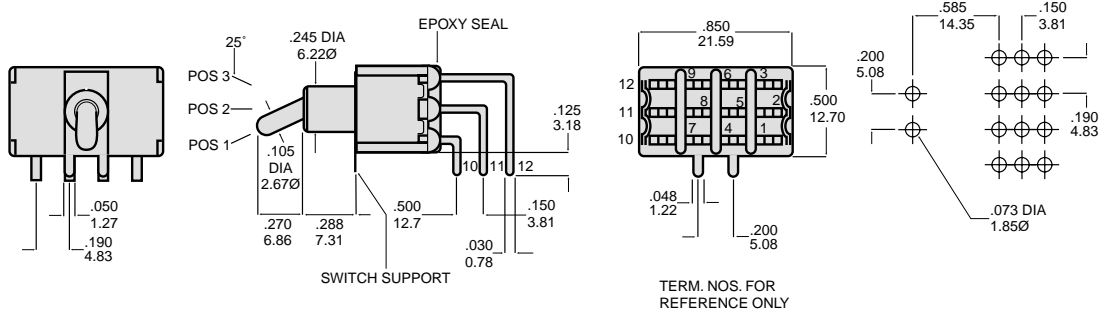

VS2-VS3 SPDT

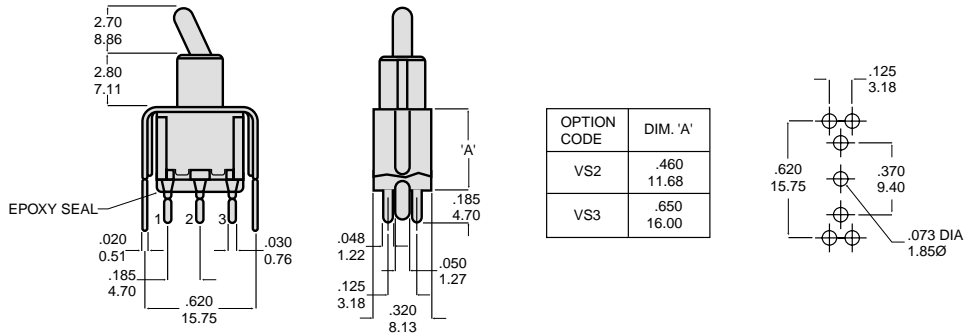

VS2-VS3 DPDT

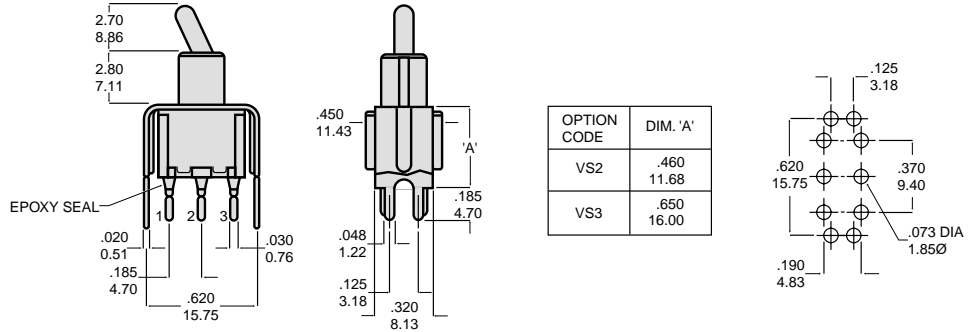

VS5 DPDT

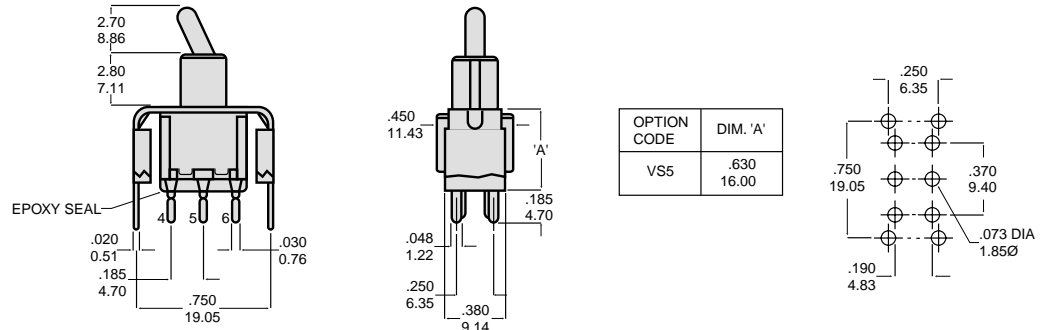

Panel Mounting

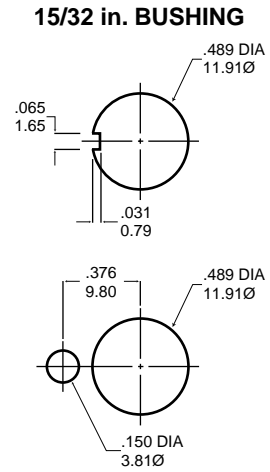
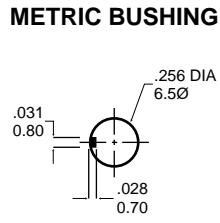
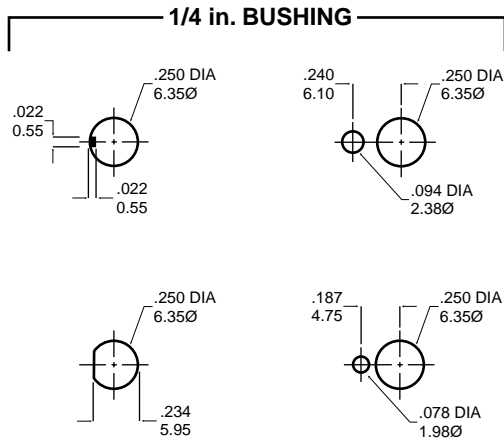

Actuator Options

T1 STD

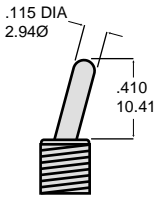

T2

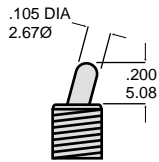

T3

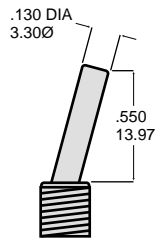

T4

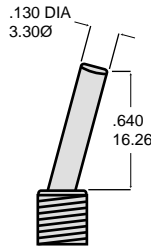

T5

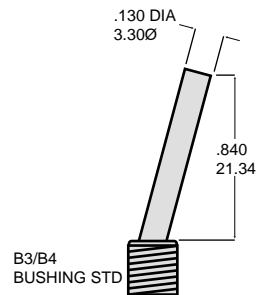

T6 FLATTED WITH BUILT IN ANTIROTATION

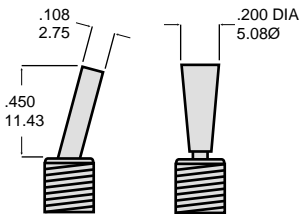

USE WITH B11, B12, B15, B16 ONLY

T7

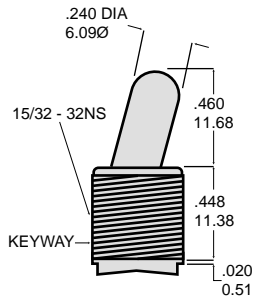

USE WITH B13 BUSHING

T8

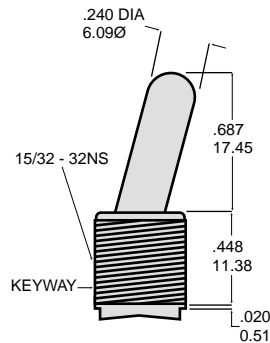

USE WITH B13 BUSHING

T9 PLASTIC BLACK

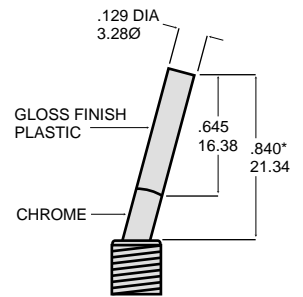

B3/B4 BUSHING STD

NOTE: *Add .070 (1.78) for B3, B4 bushings, subtract .020 (0.51) for B6 bushing.



Phone (203) 272-2794 • Fax (203) 272-3492 • <http://www.osloswitch.com>

Bushing Options

**B1 THD STD
B2 NON-THD**

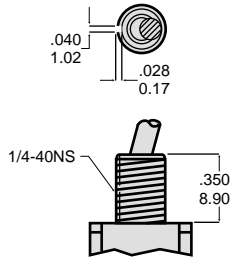

**B3 THD
B4 NON-THD**

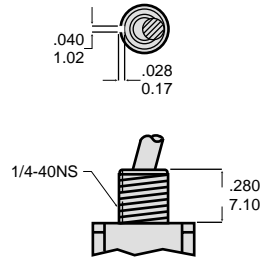

B4 IS STANDARD FOR M6,
M7 AND VS TERMINATION OPTIONS.

B5 HIGH TORQUE

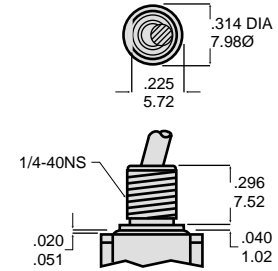

B6 HIGH TORQUE

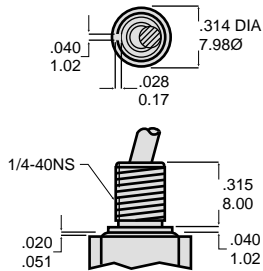

B8 METRIC THD

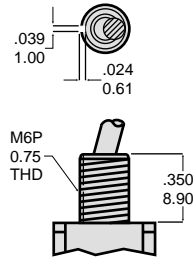

B9 SPLASH PROOF

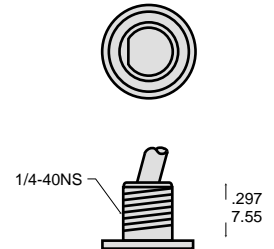

B 13

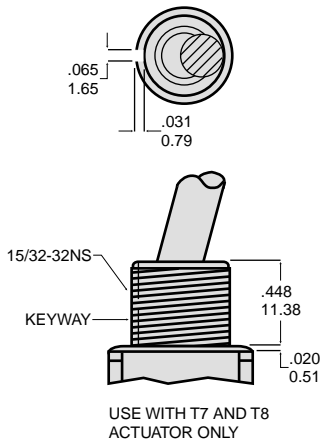

**B11 THD STD
B12 NON-THD**

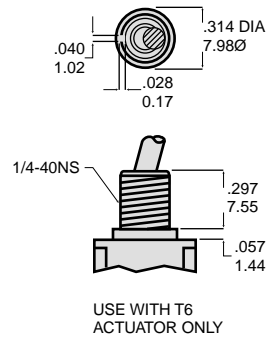

**B15 THD STD
B16 NON-THD**

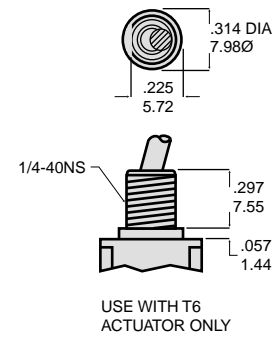

OPTIONAL TOGGLE CAP
T100-1 WHITE
T100-2 BLACK

